

Assembly and Adjusting Instructions for Modules 6x6 and 4x4 Alignment Adapter

Translated version of the instructions
Version: 11/2017

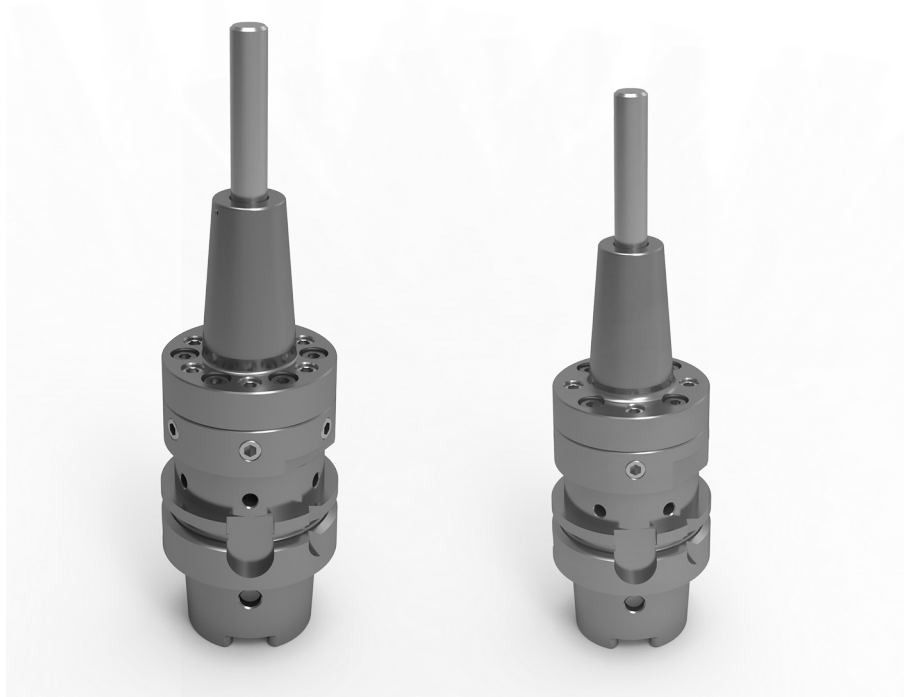

The document was prepared by Gühring KG.

All rights on this documentation, in particular the right of copying, distributing and translating the document remain with Gühring KG, also for the case of the registration of patent rights. No part of this document may be reproduced or be processed, copied or distributed with electronic media without prior written approval from Gühring KG.



CONTENTS

1	Information About these Instructions	3
1.1	Read the Operating Instructions	3
1.2	Explanation of the General Icons	3
1.3	Representation of Requirements and Work Instructions	4
1.3.1	Requirements	4
1.3.2	Work Instructions with Fixed Sequence	4
2	Identification of the Tool	4
2.1	Tool Identification	4
2.2	Manufacturer Specifications	4
3	Tool Description, Specifications	5
3.1	Intended Use	5
3.2	Improper Use	5
3.3	Specifications	5
4	Basic Safety Instructions	6
5	Installing and Adjusting the Tool	6
5.1	Initial Safety Notes	6
5.2	Variants of the Module Alignment Adapter and the Module Flange	6
5.3	Designation of the Individual Parts	7
5.4	Cleaning the Parts	7
5.5	Assembly of the Module Alignment Adapter	9
5.6	Torque Specifications	11
5.7	Radial Alignment of the Module Flange	12
5.8	Angular Radial Alignment of the Module Flange	17



1 Information About these Instructions

1.1 Read the Operating Instructions

Use and handling of the tool described below do not come naturally and are not self-explanatory. They are therefore explained by the accompanying technical documentation.

The instructions help you to use the tool as intended, properly, effectively and safely. You should therefore read the chapters below attentively and thoroughly. If necessary, keep looking up facts that are essential for your operations.

Request new operating instructions if parts of them are lost or damaged. Always keep the operating instructions at an accessible place in the vicinity of the tool.



Important information in the enclosed "General Safety Instructions" document



The safety instructions necessary for handling the tool can be found in the brief version of the "General Safety Instructions" that is enclosed to the tool.

Ensure that you read and observe this document.

Residual risks

The documents inform and warn you of residual risks for which the risk mitigation by design and protective measures takes no or no complete effect.

1.2 Explanation of the General Icons

Icon	Explanation
	Important information This icon indicates important additional information.
	Information about the machine documentation This icon refers to other parts of the documentation that must particularly or additionally be observed (for example in supplier instructions, etc.).

Tab. 1: General icons



1.3 Representation of Requirements and Work Instructions

1.3.1 Requirements

Requirements that are obligatory for the execution of an activity on the tool have a checkbox next to them in the text.

Typical requirement

...

The thread is coated with mounting lubricant

1.3.2 Work Instructions with Fixed Sequence

Many activities on the tool require the steps to be taken in a fixed sequence.

These steps have work instructions with consecutive numbering assigned. Work instructions also contain intermediate results and final results. Intermediate results show sequences that are not carried out by the user. They are identified by an arrowhead ▶. End results show the end of the action. They are identified by a tick ✓.

The sequence of the work operations is compulsory. Observing the work instructions is obligatory.

Typical work instructions with fixed sequence

1. Switch on the machine at the main switch
 - ▶ The machine controller starts up
2. Start the software
 - ▶ The software starts and the following menu appears:
 - ✓ Machine and software are ready for operation

2 Identification of the Tool

2.1 Tool Identification

Tool designation: Module alignment adapter and module flanges (module 6x6 or 4x4)

Part number / SAP no.: See Chapter 3.3 Specifications

Year of manufacture: 2017

2.2 Manufacturer Specifications

Headquarters:

Gühring KG
Herderstr. 50-54
72458 Albstadt
Germany

Phone +49 7431 17-0
Fax +49 7431 17-21279
E-mail info@guehring.de
Internet www.guehring.de



3 Tool Description, Specifications

3.1 Intended Use

Gühring Modul alignment adapters and flanges are suitable for adjusting the concentricity and angular error of tools down to the micron. This makes sense especially for projecting tools (tool length > 200 mm). Both modules (6x6 and 4x4) are suitable for conventional cooling lubrication and for minimum quantity lubrication. Depending on the type of cooling lubrication the user chooses, the length adjustment screw and coolant transfer set must be selected accordingly.

Tools with module alignment adapters and flanges may only be used in machines that are in a perfect condition.

3.2 Improper Use

Using module alignment adapters and flanges is not necessary for spindles with a concentricity error < 3 µm and tools with a length < 100 mm.

3.3 Specifications

Designation	Article no.
Module 6x6 alignment adapter HSK-A	4723
Module 6x6 alignment adapter SK	4725
Module 6x6 alignment adapter BT	4712
Module 6x6 hydraulic expansion chuck flanges	4722
Module 6x6 shrink chuck flanges	4717
Module 6x6 HPC chuck flanges	4714
Module 4x4 alignment adapter HSK-A	4297
Module 4x4 alignment adapter SK	4724
Module 4x4 alignment adapter BT	4709
Module 4x4 hydraulic expansion chuck flanges	4360
Module 4x4 shrink chuck flanges	4760
Length adjustment screw for conventional cooling	4941
Intermediate sleeve	4716
Angular alignment unit	4715

Tab. 2: Article no. Overview module 6x6 and 4x4 alignment adapter

Emission values

Important information

While the tool does not cause any emission, the machine in which the tool is used does. Always observe the operating instructions of the machine!





4 Basic Safety Instructions



Important information in the enclosed "General Safety Instructions" document

The safety instructions necessary for handling the tool can be found in the document "General Safety Instructions". This can be accessed and downloaded via the QR code or the link in the short version of the general safety instructions that come with the tool.

If you do not have internet access or want the General Safety Instructions in paper form, please contact your contact person at Gühring KG.

Gühring KG will send you a hard copy of the document.

Please ensure that you read the document "General Safety Instructions" and its brief version.

5 Installing and Adjusting the Tool

5.1 Initial Safety Notes



Important information for your safety

You are responsible!

Always take note and observe the safety instructions in the document "General Safety Instructions" and the locally valid safety instructions.

5.2 Variants of the Module Alignment Adapter and the Module Flange

Module alignment adapter and module flange are available in the variants 4x4 and 6x6. The difference between the two variants is in the number of fixing screws, screws for radial adjustment and the angle adjustment screws.

4x4 means 4 fixing screws, 4 screws for radial adjustment and 4 angle adjustment screws. 6x6 means 6 screws each.

Module alignment adapters are available with HSK, SK and BT shank.

Module flanges are available with hydraulic expansion chuck, shrink chuck and HPC chuck.

The pictures in this manual are based on the module 6x6 alignment adapter HSK-A and the module 6x6 shrink chuck flange.

Instead of a tool, a test mandrel was used on the pictures.

The difference for the variant 4x4 in the individual actions is that only 4 fastening screws have to be tightened and that radial and angle adjustment has to be carried out with 4 instead of 6 screws. The rest of the handling is identical. With the 6x6 module, the adjusting screws for radial and axial adjustment are located closer together than with the 4x4 module. This means that errors can be corrected in the immediate vicinity of the measuring point.



5.3 Designation of the Individual Parts

To have a clear definition of the individual parts, we use the following exploded views to designate them:

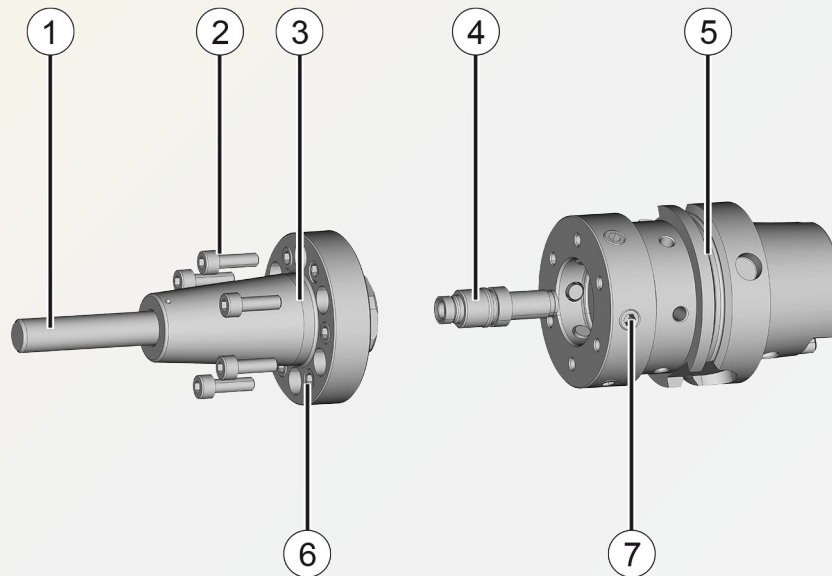

Fig. 1: Exploded view module 6x6 alignment adapter

1	Test mandrel	2	Fastening screws	3	Module 6x6 shrink chuck flange
4	Intermediate sleeve	5	Module 6x6 alignment adapter	6	Screws for angle adjustment
7	Screws for radial adjustment				

5.4 Cleaning the Parts

Requirements:

- Cleaning agent
- Cleaning cloth
- Module alignment adapter
- Module flange



Use the following procedure to clean the module alignment adapter parts:

1. Clean the flat surfaces of the module alignment adapter (1) and the module flange (2) with the cleaning agent and a cleaning cloth.



Fig. 2: Module alignment adapter (1)



Fig. 3: Module flange (2)

- ✓ Cleaning the parts is completed.



5.5 Assembly of the Module Alignment Adapter

Requirements:

- Step 5.4 Cleaning of the parts has been carried out
- Intermediate sleeve
- Module alignment adapter
- Module flange
- Fastening screws
- Thin oil
- Torque wrench with suitable hexagon socket wrench
- Hexagon socket wrench

Use the following procedure to install the parts of the module alignment adapter:

1. Insert the intermediate sleeve (1) up to the stop into the plug-in bore of the module flange.

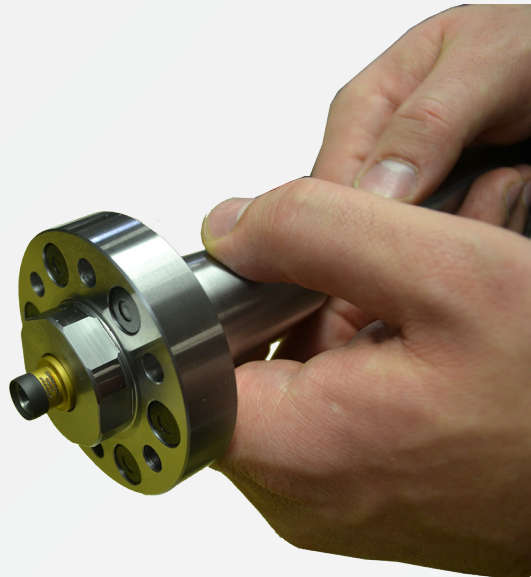

Fig. 4: Inserting the intermediate sleeve into the insertion hole

2. Lightly oil the sealing lip of the intermediate sleeve.



3. Fit the module flange with the intermediate sleeve into the module alignment adapter.
To prevent damage, carefully insert the sealing lip of the intermediate sleeve into the centric locating hole of the module alignment adapter.

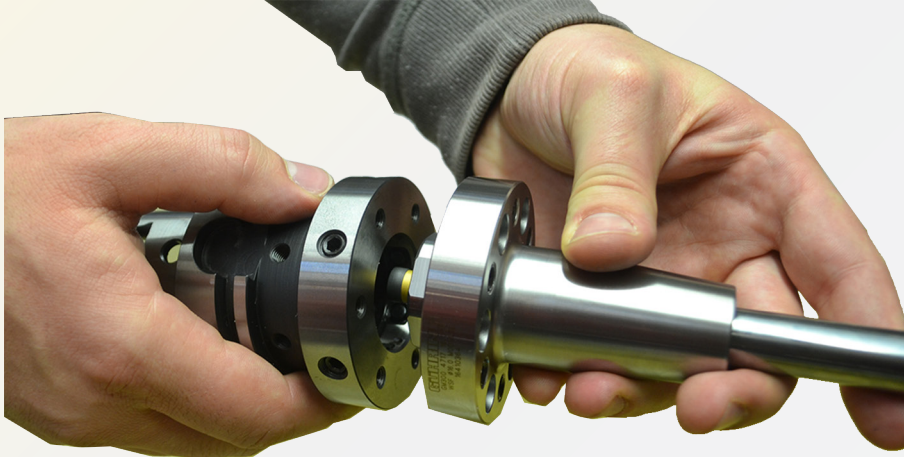

Fig. 5: Fitting the module flange into the module Alignment adapter

4. Turn the module flange such that the holes for the fastening screws are on top of each other. Screw in the fastening screws and tighten them slightly.



Fig. 6: Slightly tighten the fastening screws

5. Secure the tool in a tool mounting block (e. g. Gühring part no. 4946).



Important information

The following assembly steps could damage the spindle of setting or measuring machines and should therefore not be carried out in the spindle.

6. Tighten the fastening screws to 50% of the specified torque. The values can be found in the table in chapter 5.6. Use a torque wrench with matching internal hexagon socket wrench.



Fig. 7: Tightening the fastening screws with torque

- ✓ The module alignment adapter is installed and can now be aligned.

5.6 Torque Specifications

Module diameter	Fastening screw	Tightening torque [Nm]
60	DIN 912-M5x16-12.9	8.7
70	DIN 912-M6x20-12.9	15
80	DIN 912-M6x20-12.9	15
100	DIN 912-M8x25-12.9	36
117	DIN 912-M8x25-12.9	36
140	DIN 912-M10x30-12.9	72



5.7 Radial Alignment of the Module Flange

Requirements:

- Step 5.5 Mounting of the module alignment adapter has been carried out
- Dial indicator + stand
- Torque wrench with suitable hexagon socket wrench

We recommend that the alignment be carried out directly in the machine spindle. This achieves a higher accuracy.

Use the following procedure to align the module alignment adapter radially:

1. Clamp the tool in the machine spindle or in your measuring and setting device.
2. Position the dial indicator at the concentricity checkpoint (grinded module collar diameter).



Fig. 8: Positioning the dial indicator at the concentricity checkpoint



3. Rotate the module alignment adapter to find the highest measuring point. Note down the dial indicator reading (0.04 mm in this example).



Fig. 9: Reading of the dial indicator

4. Set the dial indicator to zero.



Fig. 10: Setting the dial indicator to zero



5. Align the module flange roughly to approx. 0.01 mm concentricity. To do this, turn the screw for the radial adjustment on the side of the dial indicator to the right using a suitable Allen key until the dial indicator pointer points to half of the concentricity error (0.020 mm in this example) to the left. Next, loosen the screw for the radial adjustment. Repeat this procedure from point 3 until the concentricity error is approx. 0.01 mm.



Fig. 11: Adjusting the concentricity error

6. Secure the tool in a tool mounting block (e. g. Gühring part no. 4946)



Important information

The following assembly steps could damage the spindle of setting or measuring machines and should therefore not be carried out in the spindle.



7. Tighten the fastening screws to the specified torque. The values can be found in the table in chapter 5.6. Use a torque wrench with matching internal hexagon socket wrench.



Fig. 12: Tightening the fastening screws with torque

8. Turn the module alignment adapter to check the concentricity again. Using the screws for the radial adjustment, adjust the concentricity as described above before loosening the screws again. Repeat this procedure until the concentricity error is $\leq 3 \mu\text{m}$.
9. Lightly tighten all screws for the radial adjustment.



10. Turn the module alignment adapter to check the concentricity again. The concentricity error must be $\leq 3 \mu\text{m}$, otherwise a new adjustment after loosening all screws is necessary.



Fig. 13: Checking the concentricity error

- ✓ The radial alignment of the module flange is completed.



5.8 Angular Radial Alignment of the Module Flange

Requirements:

- Step 5.7 Radial alignment of the module flange has been carried out
- Dial indicator + stand
- Hexagon socket wrench

Use the following procedure to adjust the module flange:

1. Position the dial indicator at the front concentricity checkpoint (at the cutting edge). If there is no concentricity checkpoint, position the dial indicator as far forward as possible on a cylindrical bevel, a guide rail or the cutting edge.



Important information

Always turn the tool only in the opposite direction to the cutting direction, otherwise the sensitive cutting edge could be damaged.



Fig. 14: Position the dial gauge at the front concentricity checkpoint



2. Rotate the tool against the cutting direction to find the highest measuring point. Note down the dial indicator reading (0.01 mm in this example).

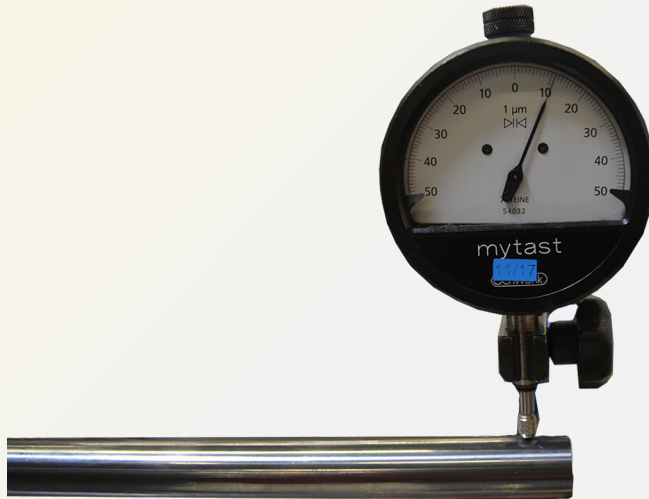

Fig. 15: Finding the highest measuring point

3. Set the dial indicator to zero.



Fig. 16: Setting the dial indicator to zero



4. Using the angle adjustment screws, align the angle to $\leq 3 \mu\text{m}$.

To do this, turn the angle adjustment screw on the side of the dial indicator to the right. Turn the screw until the dial indicator pointer points to half the angular error (0.005 mm in this example) to the left. Use a suitable Allen key for this purpose.



Fig. 17: Aligning the angle with the angle adjustment screws

The angle adjustment screws used remain clamped after alignment. Repeat this procedure until the angular error is $\leq 3 \mu\text{m}$.



Important information

Mark the angle adjustment screws used.

Use a maximum of 3 angle adjustment screws to adjust the angle alignment.

Manually tighten the other angle adjustment screws and check the angle adjustment again. Manually tightening the angle adjustment screws must not change the adjustment.

If the angle error is $> 3 \mu\text{m}$ after you have tightened the screws, loosen all angle adjustment screws and start the angular alignment of the module flange (chapter 5.8) again from the beginning.



5. Check the radial alignment of the module flange again at the concentricity checkpoint (grinded module collar diameter) and correct if necessary as described in chapter 5.7.



Fig. 18: Checking the radial alignment of the module flange

- ▶ If it is necessary to correct the radial alignment, you also have to check the angle adjustment again and correct it if necessary.
- ✓ The angle of the module flange is aligned and the tool is now ready for use.